



CURTAIN LIBRARY
&
BLINDS EXPRESS
INTERIORS AND SOFT FURNISHINGS



PRODUCT
GUIDE

Bespoke Indoor and Outdoor Blinds
and Shutters, Curtains & Upholstery



curtains

We have 35+ years of expertise in designing and manufacturing curtains. For value and quality, select from our curtains range. Large selection of full-length ready-made curtains.

- + curtains
- + tracks & rods
- + blockout curtains
- + pelmets
- + scatter cushions
- + sheer curtains
- + valances/swags & tails
- + tie backs



blinds

The difference in our blinds is in the detail. Our technically superior hardware systems have been designed for precision operation. Our blinds are also designed with extra componentry as standard, at no extra cost, to ensure the most durable and long lasting blinds available.

- + roller blinds
- + cellular blinds
- + panel blinds
- + cassettes & side channels
- + double roller blinds
- + venetian blinds
- + roman blinds
- + vertical blinds
- + valance in blind fabrics



shutters

Transform your home with our stylish, versatile and affordable shutters, offering you complete flexibility with light control, privacy and insulation. Our elliptical shape blade design increases blade closure and our wooden shutters are available in a choice of a 1000 colours.

- + 100% basswood timber shutters
- + pvc shutters
- + indoor/outdoor aluminium shutters

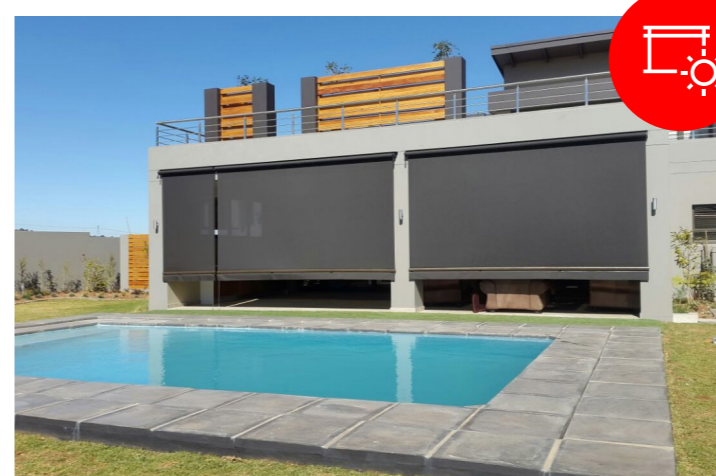

outdoor

Whether your're looking for a window awning to provide shade or increase your home's insulation, or an alfresco roller to create an all-inclusive outdoor room, we have the outdoor product to suit - all custom made to fit your external shading requirements.

- + window awnings
- + folding arm awnings
- + aluminium shutters
- + free hang channel blinds
- + wire guide options
- + duch hoods and canopies



automation

Allowing you complete freedom, our innovative automation range can operate all of your home's indoor and outdoor window covering motors with the one device using ARC technology. Control one window covering individually or all of your window coverings as a group at the one time, from a single control.

- + smart phone and tablet app control
- + exclusive dc+bv control app
- + voice control with your smart device
- + building management systems
- + sensors and accessories

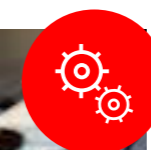
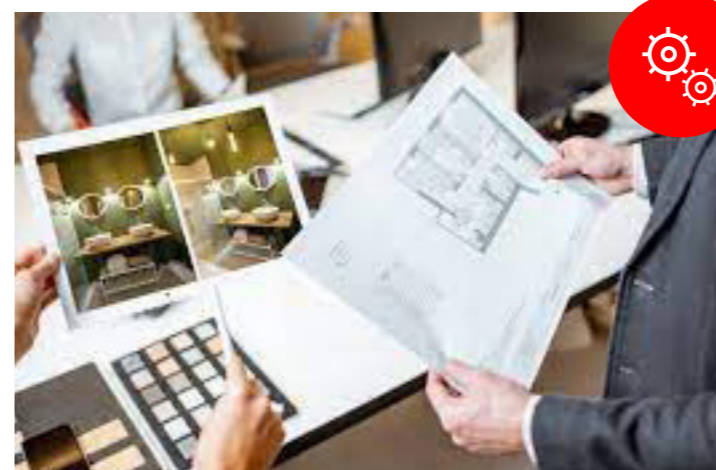

commercial service

We offer a complete Consulting, Contracting, Installation and Quality Assurance service to Architects, Specifiers, Project Managers and Developers working on Commercial Projects of any size. Working with our Suppliers we tailor-make volume solutions for new developments and re-fits. Our Automation Services in this regard provide Environmentally Friendly, economic solutions based on scale.



About Us

"Curtain Library / Blinds Express"

Curtain Library was founded in 1986.

Our business has developed and grown over the past 35 years and our offering has been expanded, from originally selling Curtains to now including Interior Decorating Consulting Services, Indoor and Outdoor Blinds, Upholstery and Soft Furnishings, and our latest evolution into the world of Automation.

Growth has meant that we have needed to take on additional premises and re-locate from our original Randburg address, to our current Showroom at Décor World in Strijdom Park.

Our Team

We employ and contract with a highly experienced team of consultants and installers who have all been qualified by internal training as well as being inundated with regular product knowledge training and insight from our Suppliers. The team's extensive product knowledge ensures that you, our loyal client base, will receive a well-designed and bespoke finished result, that matches your exact needs, expertly installed and backed up by our assurance as well as that of our reputable Suppliers.

Our Installation team has spent 35 years doing their work and have successfully completed thousands of blinds and interior installations for both commercial and residential customers.

"Curtain Library / Blinds Express" boasts a staff complement of twelve full-time employees, including six blinds and decorating consultants with over 100 years' cumulative experience in their Interior Design, Decorating and Contracting services. We have two dedicated and highly experienced installation teams, backed up and supported by a professional and competent administration team.

We encourage our clients to regularly book maintenance, adjustment and repair visits from our team of Installers who would be only too pleased to oblige.

Our Suppliers

What distinguishes "Curtain Library / Blinds Express" in our Industry, is the relationship we have with the most reputable range of quality local and international Suppliers for each product.

These relationships guarantee us excellent lead times, fantastic prices and discounts which we are able to pass on to our clients and customers, and superb after-sale service which matches our own internal commitment to our client base.

Collectively from our chosen group of Suppliers, we have sourced and are able to offer you a comprehensive broad range of quality products, an exhaustive palette of colours and styles of product backed up with the expertise to guide you in making the best choices to cater to your needs.

From our modern 450 sqm showroom at Décor World, "Curtain Library / Blinds Express" has curated a large selection on display, of swatches and samples from local and international fabric houses, as well as decorating ideas and over 60 Indoor and Outdoor Blinds and Shutters, on permanent display.

We continually monitor our suppliers to ensure that both their supply-chains and the quality of their products meet our uncompromising demands.

Our Geographic Footprint

From our base in Gauteng, "Curtain Library / Blinds Express" regularly supplies and services clients throughout many Provinces in South Africa as well as further afield in Angola, Botswana, the DRC, Lesotho, Namibia, Nigeria, Zambia and Zimbabwe.



CURTAIN LIBRARY
&
BLINDS EXPRESS
INTERIORS AND SOFT FURNISHINGS

Curtains

Whether you're looking for blackout curtains or soft sheer curtains, custom curtains define the interior design of a room and have an abundance of practical benefits which allow you to have complete control over your home's environment. The visual and practical benefits of our curtains make them a wise investment that adds value to your home or commercial enterprise.

At CLBE our bespoke curtains mean you can be sure of a higher standard of quality, more variety and better service; all vital advantages.

- + Ultimate light control
- + Complete privacy
- + Ideal choice for thermal and sound insulation
- + Add value to your home
- + UV protection for furniture, furnishings and flooring
- + Flexibility - Choose your style, fabric, transparency, colour, finish, control type and accessories from our large range
- + No limitations - custom made to any window size or shape
- + No short cuts - 100% custom designed and manufactured
- + Consistent quality - Every curtain goes through stringent quality control testing
- + Market leading - The highest quality fabrics and componentry made to last
- + Peace of mind with our child and pet safe controls
- + Smooth, quiet and easy to use operation



EXCLUSIVITY HAS A NEW HOME



RIVER FABRICS



Quality is key with fabrics as each fabric has its own unique characteristics and performance levels. With the largest selection of curtain fabrics, you've come to the right place.

CLBE fabrics

- + On-trend exclusive fabrics
- + High Quality - Designed and tested

why our fabrics

- + Fabric and colour range
- + Trusted market leading brands
- + Quality Made fabrics
- + Thermal insulation - saving you money on your energy bills
- + Coordinating blind and drapery ranges
- + Flame retardant fabrics
- + Lead and PVC free fabrics
- + UV and fade resistant fabrics
- + Easy to clean, stain and dust resistant fabrics



Curtain Accessories, Automation and Complementary Soft Furnishings

select tracking

Tracks complete the look of your curtains and our made to measure tracks allow us to custom fit to any size and shape window. Our standard tracking is custom made from high quality powder coated aluminium.

We can mount tracks onto **ceilings, arcs** or **walls**, allowing great flexibility.

With **single or double tracks**, the designs are limitless. Double tracks combine more than one window covering, allowing you to layer sheer curtains beneath blackout curtains + vice versa. This adds interior design aesthetics but also boosts your insulation.

We design custom **bent and curved tracks** to go around corners, designed exactly to the size and shape required.

For a more decorative look opt for our **decorator rods**.

Add the finishing touches to our decorator rods with our **rings and finials**. Decorative in nature, rings attach to the rod and allow your window treatments to easily open and close, while finials, the decorative pieces at the end of a rod, allow you to customise your look.



decorator rods

25MM, 29MM & 38MM DECORATOR TRACKED RODS

- + Use with our pinch pleat, knife pleat, reverse pleat and other pleated styles
- + Provided with runners to use as a track
- + Plain finish
- + Paired with finials or end caps
- + Hand drawn operation

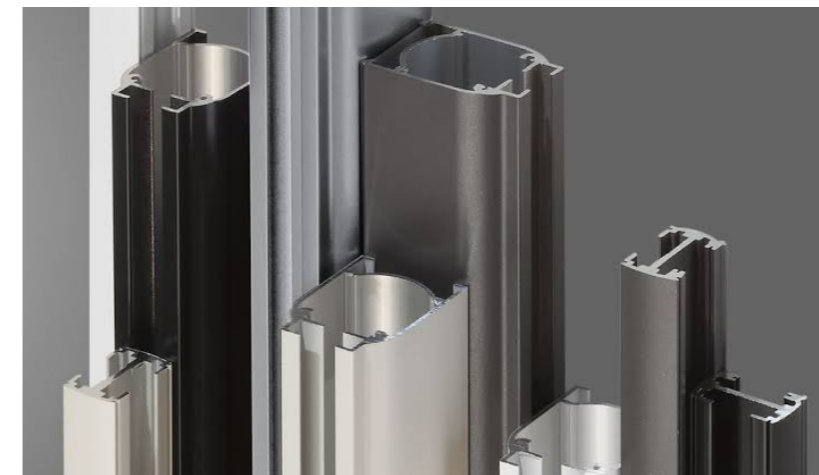
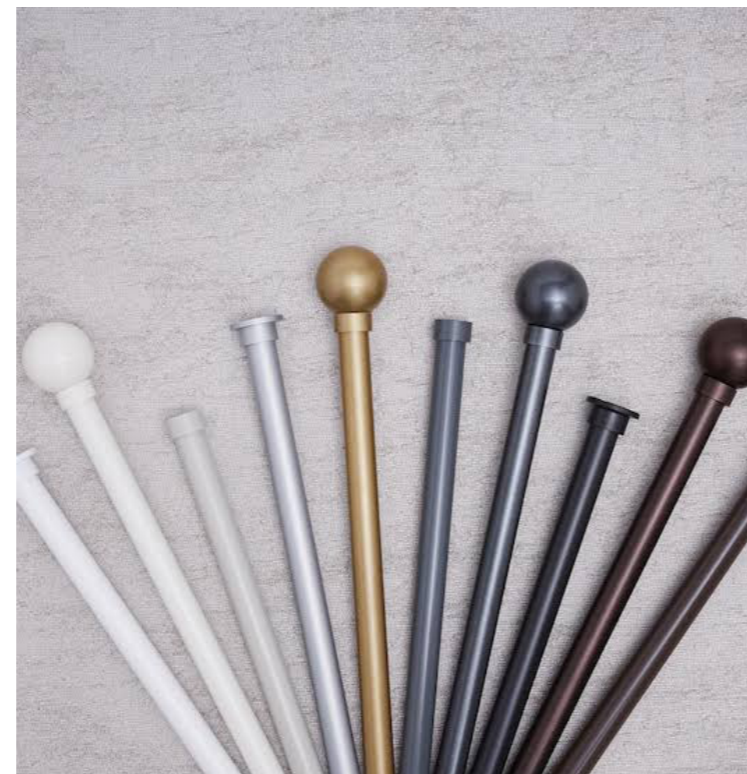

Select | Control type

Choose from hand drawn, cord drawn or motorised tracking. All operations accommodate a one way draw for single curtain panels or two way draw for dual curtain panels. All are available on single tracks or double tracks for double curtains.

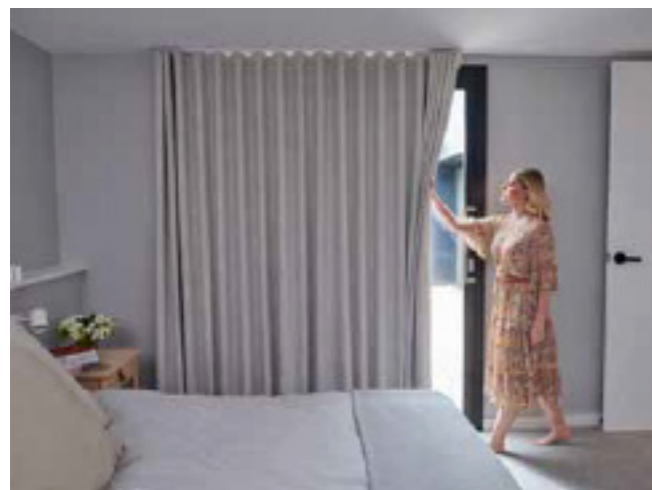

hand drawn

- + Child and pet safe
- + Highly adaptable
- + Can enable flexibility for large window configurations
- + Centre open, one way open or free draw open
- + Add wands, available in varying sizes, to easily operate and protect fabric



cord drawn

- + Easy operation with cords secured in position to walls behind curtains for child and pet safety
- + Centre open or one way open
- + Ideal for large windows to help with weight of fabric
- + Improves stack back when curtains are drawn open as tension is increased to maximise windows natural light and views

motorised

Our innovative Automation range can operate all of your home's indoor and outdoor window covering motors with the one device using ARC technology.

Our Pulse Hub allows you to accurately control your window coverings via our 'control' app on your iOS or Android smartphone or tablet, or via voice control.

For voice control, set up our Pulse Hub with your preferred smart device to easily control your window coverings with simple voice commands.

Our remotes are the foundation of your motorisation system featuring tactile push button controls, 15 channels, group controls and slimline wall mounts. Remote designs vary depending on the motor chosen.

Our system also allows your curtains to be operated manually, without power, when necessary.

- + Child and pet safe
- + Easy to operate
- + Control one curtain individually or as a group at one time, from a single remote
- + Operate your curtains from anywhere
- + Battery operated or hard wired motors
- + Suitable for difficult to reach windows
- + Operate heavy window coverings with ease



Select | Accessories



pelmet

A perfect addition over your curtains, our custom made pelmets finish off your windows for a neat streamlined look and add further insulation by trapping air at the top of your window. For a softer look we also have valances and the more traditional swags and tails.



why our pelmets

- + Increase insulation and save money on your power bills
- + Increase light control
- + Conceal hardware underneath
- + Frame your windows
- + The largest range of designs
- + Corner window? No problem! Our angled pelmets are designed for corner or bay windows

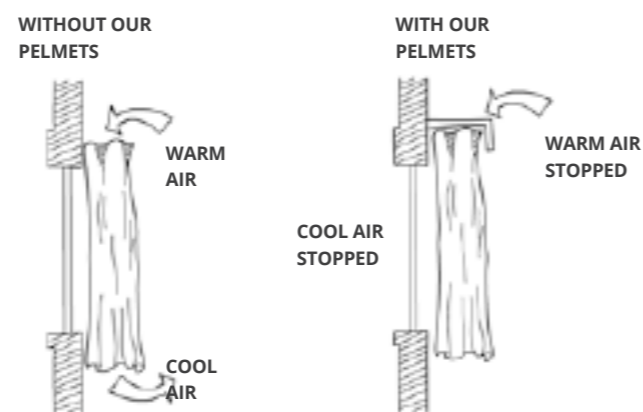

scatter cushions

Scatter cushions are an inexpensive way to give your home a style update. Adding the finishing touch, they create a complete home interior look and are perfect to inject colour into a room. We custom make cushions to all shapes and sizes, with or without piping, to coordinate back with your curtains, soft roman blinds and bonded blinds. We can also design window seat cushions made to fit your furniture.



tie backs

Our tie backs, hold backs and tassels enhance a room by adding a decorative touch to your curtains, as well as adding a functional element, holding your curtains to the side and framing your windows.



Upholstery

DECIDING WHEN TO REUPHOLSTER

Deciding on the question of when you should reupholster an old piece of furniture depends on several factors.

These factors should be carefully considered in advance of committing to what can be an expensive undertaking.

While you are potentially saving this furniture from being thrown out and opting for the more sustainable option, know that reupholstering an old piece could end up costing more than you would pay for a new one.

Also bear in mind that you may be only having it re-covered and are not planning to change its insides. To upholster is to fit padding, stuffing, springs & webbing, and not just to re-cover.

Going to such expense is generally only considered to be worthwhile under a few conditions.

If the piece is a Family Heirloom

If the piece has been in your family for a while and has been a prized possession with history and special sentimental value, you may want to hold on to it. There are certain things that are irreplaceable, and you cannot put a monetary value on them.

If the piece is a Valuable Antique

When you have an item that dates back to more than a century, and you have invested good money in it, reupholstering it makes sense. This is not something that can be replaced by a brand-new sofa.

In this case, by reupholstering, you are restoring an antique. However, you should not be attempting the reupholstering on your own. Get a qualified professional to do it. It may be more costly, but it will be a worthwhile investment.

Vintage-retro sofas are currently very popular and, if you want to keep or purchase an on-trend but tired piece like this, it may also be worth reupholstering.

If the item Has Good Bones

It makes sense to reupholster if your piece is very high quality or has an unusual frame. It is possible that the cost of reupholstering it would be less than buying a new item of comparable quality.

You may have a perfectly good sofa that can be brought back to life by just re-covering with a new fabric. It may also be difficult to source a new sofa with the same type of frame if it is something more specialized. Plus, if it is a particularly comfortable sofa that, other than the upholstery, is in good condition, you may not want to part with it.

Just make sure that it has a sturdy frame and good lines if it is to be considered worth the investment of reupholstering.

If Reupholstering Costs Less

If it is a very good quality item, and the cost of reupholstering it comes out less than getting a new item of comparable value, by all means, go for it. You may want to get quotes from two or three different reupholsterers for all fabric and parts, and then weigh it against what you would pay for a new item of the same quality.

Remember that there is a difference between re-covering and reupholstering. Re-covering involves just replacing the fabric, and it is more of a cosmetic procedure. Reupholstering could involve replacing the padding and springs, mending the frame, or restaining any wood. A complete re-upholstery job involves a lot of labour and replacement of material and is more structural in nature.

If you are just tired of the fabric you have right now but don't want to invest in a new piece of furniture, you may also want to look into slipcovers.

In the end, it is simply a question of finding the best value.





Indoor Blinds

Indoor Blinds | Roller Blinds

Roller blinds offer a simple and stylish solution to any homeowner. The wide range of designs, textures and material types ensure that they complement and enhance the décor in your home. Different areas of the home may require different types of materials, such as block-out materials for a bedroom, which give complete privacy, darkness and insulation. Double rollers are also available to allow for two effects.

Suitability Rating

- Sun protection 2 – 5
- Cooling 2 – 5
- Darkening 2 – 5
- Insulation 3 – 4
- Anti-glare 4 – 5
- Easy to clean 3 – 4
- Durability 3
- Humidity 3 – 4
- Privacy 3 – 5
- Affordability 2 – 4
- Anti-corrosion 5
- Close fit 4

RATING KEY

1. Poor
2. Not ideal
3. Average
4. Good
5. Excellent

VARIATIONS

- Translucent
- Dimount
- Block-out

**3 YEAR
WARRANTY**

ON QUALITY &
WORKMANSHIP

AVAILABLE

Fire resistant
Heat Reflective
Anti-Microbial

Pelmet Options available

Motorisation: Wired and battery powered available

Note: Ratings only indicative and are dependent on fabrics chosen as well as individual environments.

Max Width: 4200mm (dependent on fabric limitations)

Max Length: 5000mm (fabric and weight limitations may apply)

Care Instructions: Regular feather dusting for light cleaning and maintenance. Spot clean fabric with a soft, damp cloth or sponge.



Indoor Blinds | Roman Blinds

Roman blinds add a classy and graceful finish to any room, combining the sumptuous feel of materials with contemporary design. The soft folds of Roman blinds combined with a functional operating system are the perfect solution for any window covering and are guaranteed to enhance your choice of décor. Most of our roller blinds fabrics can also be used with our Roman blinds.

Suitability Rating

☀ Sun protection	2 – 5
❄ Cooling	2 – 5
🌑 Darkening	2 – 5
🏠 Insulation	3 – 4
👁 Anti-glare	4 – 5
🧴 Easy to clean	3 – 4
🔧 Durability	3
💧 Humidity	3
👁 Privacy	3 – 5
💰 Affordability	2
🛡 Anti-corrosion	5
🖼 Close fit	4

RATING KEY

1. Poor
2. Not ideal
3. Average
4. Good
5. Excellent

VARIATIONS

- ☐ Translucent
- ☐ Dimount
- ☐ Block-out

3 YEAR WARRANTY

ON QUALITY & WORKMANSHIP

ACCESSORIES

Ladder tapes,
Wooden extras,
Hold-down bracket

Pelmet Options available

⚡ Motorisation

Wired and battery powered available

Note: Ratings only indicative and are dependent on fabrics chosen as well as individual environments.

Max Width: 5000mm (dependent on fabric limitations)

Max Length: 4500mm (fabric and weight limitations may apply)

Care Instructions: Regular feather dusting for light cleaning and maintenance. Spot clean fabric with a soft, damp cloth or sponge.



Indoor Blinds | Aluminium Venetians

Versatile, long lasting and affordable. These blinds are made from a specialised aluminium alloy, these blinds are offered in slat widths of 25mm and 50mm. We offer various finishes ranging from metallic and wood effect to plain finishes. Perforated options add a modern touch and are the perfect accessory to today's kitchens with steel appliances and chrome or gold fittings.

Suitability Rating

☀ Sun protection	4
❄ Cooling	4
🌑 Darkening	4
🏠 Insulation	2
👁 Anti-glare	5
🧼 Easy to clean	2 – 3
🔧 Durability	3 – 4
💧 Humidity	2 – 4
👁 Privacy	4
💰 Affordability	4 – 5
🛡 Anti-corrosion	3 – 4
🖼 Close fit	4

RATING KEY

1. Poor
2. Not ideal
3. Average
4. Good
5. Excellent

VARIATIONS

- 25mm
- 50mm

3 YEAR WARRANTY

ON QUALITY & WORKMANSHIP

ACCESSORIES

Ladder tapes,
Wooden extras,
Hold-down bracket

 Pelmet Options available

⚡ Motorisation

Wired and battery powered available

Note: Ratings only indicative and are dependent on fabrics chosen as well as individual environments.

Max Width: 3000mm

Max Length: 3000mm

Care Instructions: Regular feather dusting for light cleaning and maintenance. Blinds can be unclipped from the bracket. Immerse in a tub of mild, soapy water, rinse and then hang up to air dry.



Indoor Blinds | Faux-Wood Venetians

Elegant, durable and timeless. That is how we describe our 50mm Simuwood and Wood Illusions Venetian blinds. Available in a wide variety of colours and textures that reflect current international trends, this investment will last a lifetime and never go out of style. They are also resistant to moisture, making them ideal for bathrooms and kitchens.

Suitability Rating

☀ Sun protection	3
❄ Cooling	3
🌑 Darkening	3
🏠 Insulation	2
👁 Anti-glare	5
🧴 Easy to clean	3
🔧 Durability	3
💧 Humidity	4
👁 Privacy	3 – 4
💰 Affordability	4
🛡 Anti-corrosion	4
🖼 Close fit	4

RATING KEY

1. Poor
2. Not ideal
3. Average
4. Good
5. Excellent

VARIATIONS

- Simuwood Wood
- Illusions

3 YEAR WARRANTY

ON QUALITY & WORKMANSHIP

ACCESSORIES

Ladder tapes,
Hold-down bracket

 Pelmet Options available

🔌 Motorisation

Wired and battery powered available

Note: Ratings only indicative and are dependent on fabrics chosen as well as individual environments.

Max Width: 2700mm (2400 for wood illusions)

Max Length: 3000mm

Care Instructions: Regular feather dusting for light cleaning and maintenance. Wipe off hardware and components with mild detergent and a soft cloth.



Indoor Blinds | Solid Wood Venetians

Made from responsibly sourced Phoenix wood, our solid wood 50mm Venetians come in many standard colours but imagine having your blind colour coded to exactly match your walls or décor. Our Custom wood Venetian Blind allows you to do just that. Ask about our 1000 custom colour options. These blinds are warp, chip fade and water resistant.

Suitability Rating

☀ Sun protection	3
❄ Cooling	3
🌑 Darkening	3
🏠 Insulation	2
👁 Anti-glare	5
🧼 Easy to clean	3
🔧 Durability	3
💧 Humidity	4
👁 Privacy	3 – 4
💰 Affordability	4
🛡 Anti-corrosion	2 – 4
🖼 Close fit	4

RATING KEY

1. Poor
2. Not ideal
3. Average
4. Good
5. Excellent

VARIATIONS

- Standard
- Custom colour

3 YEAR WARRANTY

ON QUALITY & WORKMANSHIP

ACCESSORIES

Ladder tapes,
Hold-down bracket

 Pelmet Options available

🔌 Motorisation

Wired and battery powered available

Note: Ratings only indicative and are dependent on fabrics chosen as well as individual environments.

Max Width: 2440mm

Max Length: 3000mm

Care Instructions: Regular feather dusting for light cleaning and maintenance. Wipe off hardware and components with mild detergent and a soft cloth



Indoor Blinds | Bamboo Blinds

Bamboo and woven-wood blinds create a warm atmosphere in any room. Versatile and durable, they are also an eco-friendly choice for the environmentally conscious. Bamboo blinds are handmade from totally natural material, which adds to their charm. Due to their organic nature, colour variations and imperfections in the material are not uncommon.

Suitability Rating

☀ Sun protection	2
❄ Cooling	2 – 4
🌑 Darkening	2 – 4
🏠 Insulation	2
👁 Anti-glare	3 – 4
🧴 Easy to clean	4
🔧 Durability	4 – 5
💧 Humidity	5
👁 Privacy	2 – 4
💰 Affordability	4
🛡 Anti-corrosion	5
🖼 Close fit	4

RATING KEY

1. Poor
2. Not ideal
3. Average
4. Good
5. Excellent

VARIATIONS

- Standard
- Roman style

3 YEAR WARRANTY

ON QUALITY & WORKMANSHIP

ACCESSORIES

Solid brass cleats

 Pelmet Options available

⚡ Motorisation

Wired and battery powered available

Note: Ratings only indicative and are dependent on fabrics chosen as well as individual environments.

Max Width: 2440mm

Max Length: 3000mm (Fabric dependent)

Care Instructions: Regular feather dusting for light cleaning and maintenance. Wipe off hardware and components with mild detergent and a damp cloth.



Indoor Blinds | Vertivoile Blinds

Made up of a combination of sheer and opaque textured fabric, you can decide how much light and privacy you need. Vertivoile blinds are fully retractable so you can still enjoy an open view when required. Washable, durable and available in various colours, these blinds look stunning in both bedrooms and living areas. The soft, flowing vanes allow you to walk through the blind at any point.

Suitability Rating

☀️ Sun protection	4
❄️ Cooling	2 – 3
🌑 Darkening	3
🏠 Insulation	2
👁️ Anti-glare	4
🧼 Easy to clean	4
🔧 Durability	3
💧 Humidity	3
👁️ Privacy	3
💰 Affordability	3 – 4
🛡️ Anti-corrosion	5
🖐️ Close fit	3

RATING KEY

1. Poor
2. Not ideal
3. Average
4. Good
5. Excellent

VARIATIONS

- Plain
- Floral design
- Trellis design

3 YEAR WARRANTY

ON QUALITY & WORKMANSHIP

Pelmet Options available

⚡ Motorisation
Wired and battery powered available

Note: Ratings only indicative and are dependent on fabrics chosen as well as individual environments.

Max Width: 4000mm

Max Length: 3000mm

Care Instructions: Regular feather dusting for light cleaning and maintenance. Unclip slats from head rail, roll up and hand or machine wash inside a laundry bag/stocking. To dry, clip back on while damp.



Indoor Blinds | Panel Blinds

Ideal for large openings and dramatic statements. Panels from 40cm to 120cm glide on a special aluminium track. Stacking one behind the other, these panels can be made up of almost any fabric combination, including woven wood. Panels can be made to suit your requirements by combining different fabrics on one panel using wooden accents or by alternating fabrics of your choice.

Suitability Rating

☀ Sun protection	2 – 5
❄ Cooling	2 – 5
🌑 Darkening	2 – 5
🏠 Insulation	3 – 4
👁 Anti-glare	4 – 5
🧼 Easy to clean	2 – 3
🔧 Durability	3
💧 Humidity	3
👁 Privacy	3 – 5
💰 Affordability	4
🛡 Anti-corrosion	5
🖼 Close fit	4

RATING KEY

1. Poor
2. Not ideal
3. Average
4. Good
5. Excellent

VARIATIONS

- Mixed Panels
- Alternating Panels

3 YEAR WARRANTY

ON QUALITY & WORKMANSHIP

ACCESSORIES

Wooden highlights available in over 1000 colours

 Pelmet Options available

⚡ Motorisation

Wired and battery powered available

Note: Ratings only indicative and are dependent on fabrics chosen as well as individual environments.

Max Width: 6000mm (bi-part)

Max Length: 3000mm

Care Instructions: Regular feather dusting for light cleaning and maintenance. Wipe off hardware and components with mild detergent and a damp cloth. Blot fabric for spot cleaning.



Indoor Blinds | Vertical Blinds

Vertical blinds are no longer only fit for offices. We offer comprehensive fabric options ranging from patterned, suede, linen, blackout and semi-blockout to plain materials in classic and contemporary shades. Available in 90mm and 127mm slats to suit your preference. Sewn and weighted pockets are offered to eliminate the bottom chain and supply a more elegant finish.

Suitability Rating

- Sun protection 3 – 5
- Cooling 3 – 5
- Darkening 2 – 4
- Insulation 2
- Anti-glare 4 – 5
- Easy to clean 4 – 5
- Durability 4 – 5
- Humidity 4
- Privacy 2 – 3
- Affordability 4
- Anti-corrosion 5
- Close fit 2 – 3

Motorisation
Pending

RATING KEY

1. Poor
2. Not ideal
3. Average
4. Good
5. Excellent

VARIATIONS

- Bottom chain
- Weighted, sewn pockets

Widths:

- 90mm
- 127mm

3 YEAR WARRANTY

ON QUALITY & WORKMANSHIP

Pelmet Options available

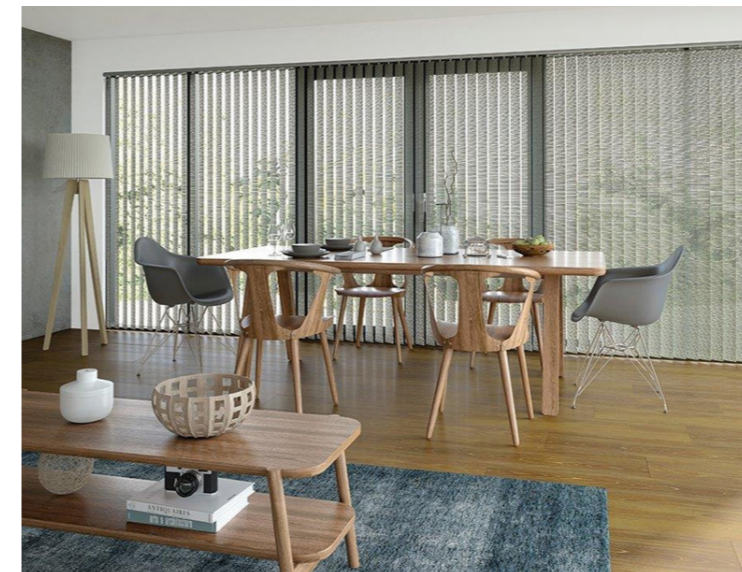

Note: Ratings only indicative and are dependent on fabrics chosen as well as individual environments.

Max Width: 5900mm

Max Length: 3500mm

Care Instructions: Regular feather dusting for light cleaning and maintenance. Wipe off hardware and components with mild detergent and a soft cloth. Blot fabric to spot clean.

Indoor Blinds | Lumi-Wave Blinds

If you prefer to be unique and always on the lookout for something unusual, we have the ideal product for you. The Lumi Wave blind is manufactured by carefully cutting each slat in a “wave” shape to provide a statement piece to your home. This blind is not only visually appealing but is fresh and exciting. The Lumi Wave is available in a host of plain Translucent colours with a “chambray” look.

Suitability Rating

☀ Sun protection	3
❄ Cooling	3
🌑 Darkening	2
🏠 Insulation	2
👁 Anti-glare	4
🧴 Easy to clean	3
🔧 Durability	3
💧 Humidity	4
👁 Privacy	4
💰 Affordability	4
🛡 Anti-corrosion	5
🖼 Close fit	2

RATING KEY

1. Poor
2. Not ideal
3. Average
4. Good
5. Excellent

VARIATIONS
 — Alternating colour slats

3 YEAR WARRANTY

ON QUALITY & WORKMANSHIP

📄 Pelmet Options available

🔌 Motorisation

Pending

Note: Ratings only indicative and are dependent on fabrics chosen as well as individual environments.

Max Width: 5900mm

Max Length: 3000mm

Care Instructions: Regular feather dusting for light cleaning and maintenance. Wipe off hardware and components with mild detergent and a soft cloth. Blot fabric to spot clean.



Indoor Blinds | Zebra Blinds

Soft horizontal fabric slats are interspersed with sheer material, which is then looped onto a headrail and bottom rail, leading to the double effect. By slight operation various combinations of fabric positions are possible: sheer material front and back allowing for maximum natural light; sheer material with fabric slat for a more muted feel; or fabric slat front and back to darken a room.

Suitability Rating

☀ Sun protection	2 – 5
❄ Cooling	2 – 5
🌑 Darkening	2 – 5
🏠 Insulation	3 – 4
👁 Anti-glare	4 – 5
🧴 Easy to clean	3 – 4
🔧 Durability	3
💧 Humidity	3 – 4
👁 Privacy	3 – 5
🏷 Affordability	2 – 4
🛡 Anti-corrosion	5
🖼 Close fit	4

RATING KEY

1. Poor
2. Not ideal
3. Average
4. Good
5. Excellent

VARIATIONS

- Simuwood Wood
- Illusions

3 YEAR WARRANTY

ON QUALITY & WORKMANSHIP

ACCESSORIES

Ladder tapes,
Hold-down bracket

Pelmet Options available

⚡ Motorisation

Wired and battery powered available

Note: Ratings only indicative and are dependent on fabrics chosen as well as individual environments.

Max Width: 2440mm

Max Length: 3000mm

Care Instructions: Regular feather dusting for light cleaning and maintenance. Wipe off hardware and components with mild detergent and a soft cloth



Indoor Blinds | Lumi-Plisse

These blinds are endlessly versatile due to the way the system operates, especially when minimal gaps are desired between blinds. Lumi plissé blinds are one of the best options when installing on doors with the guide wires ensuring the blind fits close to the glass. Choose from over 50 different configurations and shapes which can be operated by pull cords, handles or motorised. Ideal for skylight application.

Suitability Rating

☀ Sun protection	3
❄ Cooling	3
🌑 Darkening	3
🏠 Insulation	3
👁 Anti-glare	4
🧼 Easy to clean	4
🔧 Durability	4
💧 Humidity	3 - 4
👁 Privacy	3 - 4
💰 Affordability	3 - 4
🛡 Anti-corrosion	5
🖼 Close fit	5

RATING KEY

1. Poor
2. Not ideal
3. Average
4. Good
5. Excellent

VARIATIONS

- 35 shapes
- 4 control systems

3 YEAR WARRANTY

ON QUALITY & WORKMANSHIP

ACCESSORIES

Safety clips

Pelmet Options available

🔌 Motorisation

Wired and battery powered available

Note: Ratings only indicative and are dependent on fabrics chosen as well as individual environments.

Max Width: 2400mm

Max Length: 2600mm (Shape dependent)

Care Instructions: Fully washable. Unclip the blind and immerse in a tub of mild, soapy water. Rinse and then hang up to air dry. For spot cleaning blot gently to avoid damaging the product. Rubbing can damage fabrics.

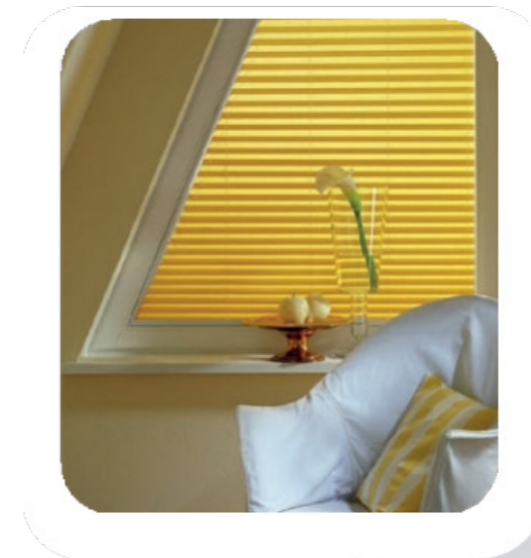

Indoor Blinds | Honeycomb Blinds

Lumi-Cel blinds are honeycomb pleated blinds made up of two layers joined at the pleats to form 'cellular' compartments. Lumi-Cel blinds offer one of the highest energy-efficient and sound absorbent blinds of all window blinds due to their cellular construction, great news if you are energy conscious. Lumi-Cel fabrics are available with varying degrees of light filtering shades, providing 100% privacy

Suitability Rating

☀️ Sun protection	2 – 5
❄️ Cooling	2 – 5
🌑 Darkening	2 – 5
🏠 Insulation	3 – 4
👁️ Anti-glare	4 – 5
🧼 Easy to clean	3 – 4
🔧 Durability	3
💧 Humidity	3 – 4
👁️ Privacy	3 – 5
💰 Affordability	2 – 4
🛡️ Anti-corrosion	5
🖼️ Close fit	4

RATING KEY

1. Poor
2. Not ideal
3. Average
4. Good
5. Excellent

VARIATIONS

- Simuwood Wood
- Illusions

3 YEAR WARRANTY

ON QUALITY & WORKMANSHIP

ACCESSORIES

Ladder tapes,
Hold-down bracket

 Pelmet Options available

⚡ Motorisation

Wired and battery powered available

Note: Ratings only indicative and are dependent on fabrics chosen as well as individual environments.

Max Width: 2440mm

Max Length: 3000mm

Care Instructions: Regular feather dusting for light cleaning and maintenance. Wipe off hardware and components with mild detergent and a soft cloth

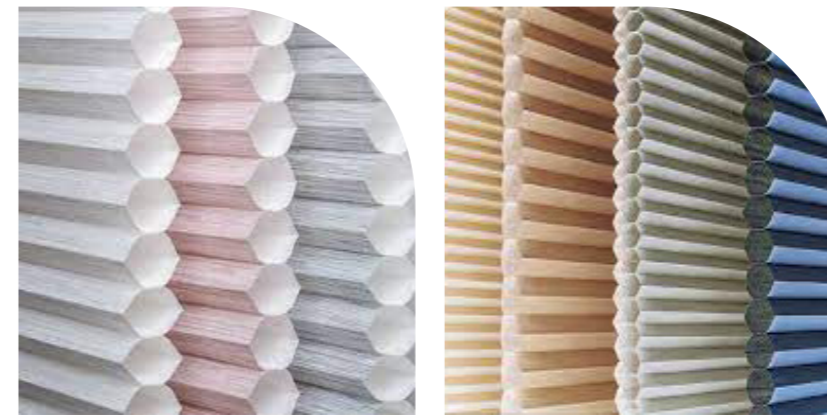

Indoor Blinds | Lumi-Voile

As the name suggests 'voile' or fine soft sheer material is suspended vertically either side of fabric covered PVC slats. Perfect for an entire wall of windows or large window opening, such as French doors. The slats can be rotated creating a myriad of degrees of light control, adding a warm glow to any room. Depending on the material chosen varying degrees of privacy are possible.

Suitability Rating

☀ Sun protection	3
❄ Cooling	3
🌑 Darkening	3
🏠 Insulation	3
👁 Anti-glare	5
🧴 Easy to clean	3
🔧 Durability	3
💧 Humidity	3
👁 Privacy	4 – 4
💰 Affordability	2 – 3
🛡 Anti-corrosion	1
🖼 Close fit	3

RATING KEY

1. Poor
2. Not ideal
3. Average
4. Good
5. Excellent

VARIATIONS

- Single stack
- Bi-Part

3 YEAR WARRANTY

ON QUALITY & WORKMANSHIP

ACCESSORIES

Safety Clips

🖼 Pelmet Options limited

🔌 Motorisation

Pending

Note: Ratings only indicative and are dependent on fabrics chosen as well as individual environments.

Max Width: 5900mm

Max Length: 2800mm

Care Instructions: Light feather dusting for cleaning and maintenance. Wipe off hardware and components with mild detergent and a soft cloth.

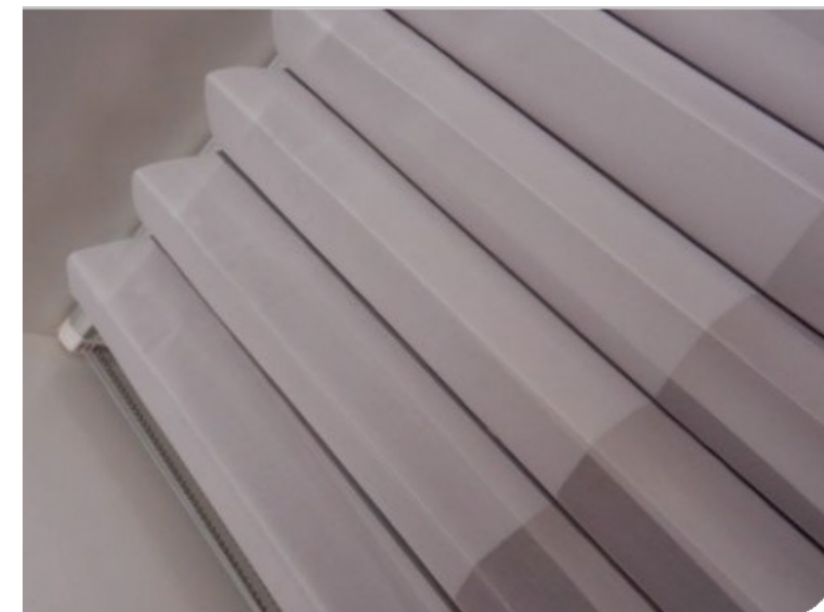

Shutters



Wooden Shutters

Curtain Library wooden shutters are manufactured to the highest quality and standards, with a variety of colours and grain finishes to choose from. Our shutters are made from Phoenix wood (also known as Kiri Wood or “the Wood of the Future”). It is lightweight yet strong, has a beautiful grain finish and does not warp, crack or deform easily. Another appealing factor is a natural resistance to wood borer as well as adaptability to a wide range of temperatures. Phoenix Wood has an excellent internal and external cladding for energy-efficient homes. These shutters are available in different systems with customisation only Curtain Library can offer.

Features and Benefits

- 100% solid, sustainably sourced wood.
- Resistant to decay, warping, splintering and splitting.
- Fire-resistant.
- Ignition temperature of 420 to 430°C (average hardwoods: 225 to 235°C).
- Natural repulsion to insects due to silica content.
- Low thermal conductivity.
- Ideal for insulation.



Aluminium Shutters

Curtain Library aluminium shutters are manufactured out of powder-coated aluminium to the highest quality standards with added security benefits. They are steam, heat, moisture and chip resistant and are available for interior and exterior use.

Curtain Library aluminium shutters are currently available in 5 standard colours and are available in three different systems with a lockable secret tilt function that is standard on the panels. The shutter has a top and bottom bolt locking set which can be used for additional protection.

Features and Benefits

- 100% weather resistant. Perfect product for internal and external installations.
- Rust-free.
- Can be well-secured with a lock and key.
- Light-weight, but very robust construction.
- SASSA certified.



Shutters



Hinged Shutter

The hinged shutter is suitable for small to medium-sized openings. Hinged shutters can consist of one or more shutter panels, which can be hinged in a variety of configurations.

The hinged option can be constructed to fit shaped windows, and allows for ease of cleaning. These are ideal for the control of light into an area.

Hinged shutters have a timeless, classic look and allow the option of decorative frames, which will enhance the look of your room. For coastal areas we offer the option of stainless steel hinges.

We offer accessories that allow for simpler functioning of the hinged system.

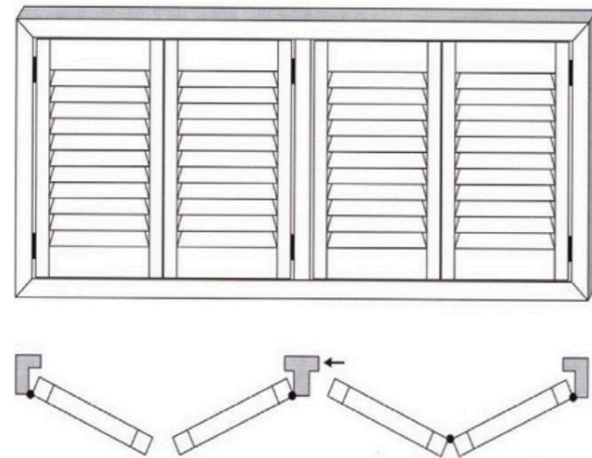

OUR WOODEN SHUTTERS ARE AVAILABLE OVER 1000 COLORS

Bi-fold Shutter

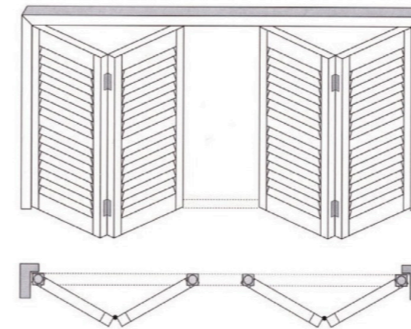

There are a number of bi-fold styles suitable for medium to large doors and windows. The bi-fold option provides a modern look that allows you to enjoy seamless indoor or outdoor views.

This option tends to create space and can be used as a divider between areas. Bi-fold shutters maximise the use of doors and windows.

Bi-fold applications require the use of a top and bottom track with the option of recessing your bottom track.

Accessories are available that allow for simpler functionality of the bi-fold system.

Bypass Shutter

The bypass system allows one to cover large openings. It is an ideal treatment for sliding doors.

Bypass shutters can be configured to match your doors or windows.

Sliding applications require the use of a top and bottom track with the option of having the bottom track recessed.

The bypass shutter can also be used as a divider to separate two areas.

Accessories are available that allow for simpler functionality of the bypass system.



Skylight Blinds

Complete control of light, smart control of heat

Adding a skylight can be a great way of making a room brighter and giving it an overall more open, airier feel.

But all that sunlight can be a little glaring – and can uncomfortably hot. That's where a skylight blind can really make a difference to the comfort in your home.

Does your new loft bedroom skylight let the early morning sun stream in? Simply choose a stylish room darkening fabric and enjoy a well-earned sleep.

Enjoy the light – control the heat

Skylights can often be an integral part of a conservatory; and if you have a conservatory, you'll know they can trap heat in summer and let heat out in the winter. There's one easy answer – simply add stylish, energy-efficient skylight blinds to give you wonderful climate control all year round plus the right amount of privacy.

Easy options for hard-to-reach skylights include our motorised operating systems which make life easier – letting you control your blinds quickly and simply with a remote control or wall switch option.

Exclusive designs, contemporary or classic colours and textures, a choice of transparencies, our complete range of Skylight blinds offer the perfect look for any and every home.

We understand that skylights really do come in quirky, one-off shapes and a vast range of sizes. So all our blinds are expertly made to measure and professionally installed – meaning you'll always know everything will fit perfectly.





Outdoor Blinds

The Outdoor Blind is the modern alternative for your patio. The hi-tech fabrics manage heat and glare on your patio while maintaining the view.

The Outdoor Blind will allow you maximum use of your external entertainment areas by stopping heat and glare and also providing a degree of weather protection while maintaining your view.



Outdoor Blinds | Free Hang Blinds



Lower and raise the blind using a removable crank handle or motorise your blind. The blind is secured at the bottom using a choice of hold down clips, which allow the blind to remain down during windy weather.

- Max Width:** 5700mm
- Max Length:** 6000mm
- Privacy:** Daytime views & privacy | Night time no privacy (One privacy range available)
- Light Control:** Diffused light
- Operation:** Crank Handle | 220V motor
- Cleaning:** Can be dusted and wiped with a damp cloth.
- Suitable for:** Controlling sun and glare and a degree of weather protection for your patio. Can also be used for large interior applications.
- Avoid:** Areas where it will not be possible to utilise the hold down system to retain the blind when fully lowered. Avoid if you require full weather protection for the outdoor area.

Outdoor Blinds | Channel X Blinds



Channel X Outdoor Blinds feature side channels to enclose the blind. This makes the blind safer to lift up and down, gives a complete wall to wall finish and provides for better insulation and weather protection. Channel X Blinds are secured at the bottom (or at halfway if you wish) using a central turn knob for maximum convenience.

Max Width: 5100mm

Max Length: 4000mm

Privacy: Daytime views & privacy | Night time no privacy (One privacy range available)

Light Control: Diffused light

Operation: Crank Handle | 220V motor

Cleaning: Can be dusted and wiped with a damp cloth.

Suitable for: The side channels allow you to move the blind into any position without securing the blind at the bottom. Channel X is suitable for controlling sun and glare and offering a degree of weather protection for your outdoor area.

Avoid: Irregular openings that aren't perfectly square or openings that have stepped tiles or skirtings' interfering with the opening. Be aware that the fabric will not be contained inside the channel at all times as gusts of wind can blow the fabric out. Also avoid if you require full weather protection for your outdoor area.

Outdoor Blinds | Mdock Wire Guide Blinds



An MDock Blind is secured from top to bottom by two stainless steel wires. The MDock system features easy tensioning of cables, the smallest possible gap at the bottom of the blind, top quality fittings and fixtures and a magnetic hold down system when the blind is in the down position. Style has never been so practical.

Max Width: 5100mm

Max Length: 4000mm

Privacy: Daytime views & privacy | Night time no privacy (One privacy range available)

Light Control: Diffused light

Operation: Crank Handle | 220V motor

Cleaning: Can be dusted and wiped with a damp cloth.

Suitable for: Areas where it is challenging to utilise a hold down system to retain the blind when fully lowered. The system works well when used together with wind sensors. Also suitable for controlling sun and glare and offering a degree of weather protection for the outdoor area.

Avoid: Locations where the blind will be exposed to wind, the magnets won't restrain the blind when it's windy. In windy areas it is recommended that the blind is motorised in conjunction with a wind sensor that will lift the blind when the wind becomes too strong. Also avoid if you require full weather protection for your outdoor area.



Automation Motorisation

Automation | Motorisation



MOTORISATION BLURB:

- + Automate your home with cutting edge technology
- + Finest quality incorporating cutting edge technology
- + Touch of a button convenience
- + Range of controllers & switching offering great flexibility
- + Can control multiple blinds & awnings from one controller
- + Add sun & wind sensors, & timers to operate while away
- + Energy efficiency by controlling heat & light entering
- + Smooth & controlled movement ensures longer life
- + Quiet, sophisticated & discreet operation. Impress guests

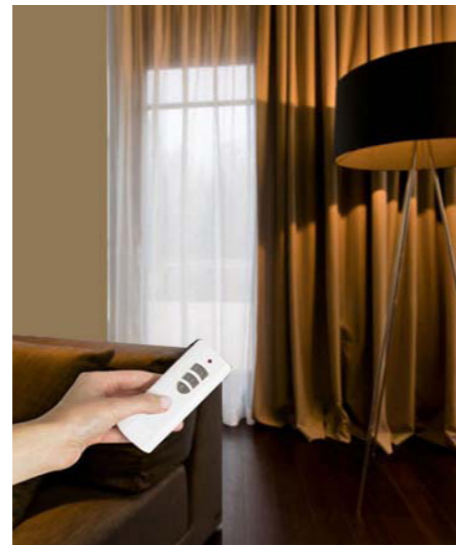
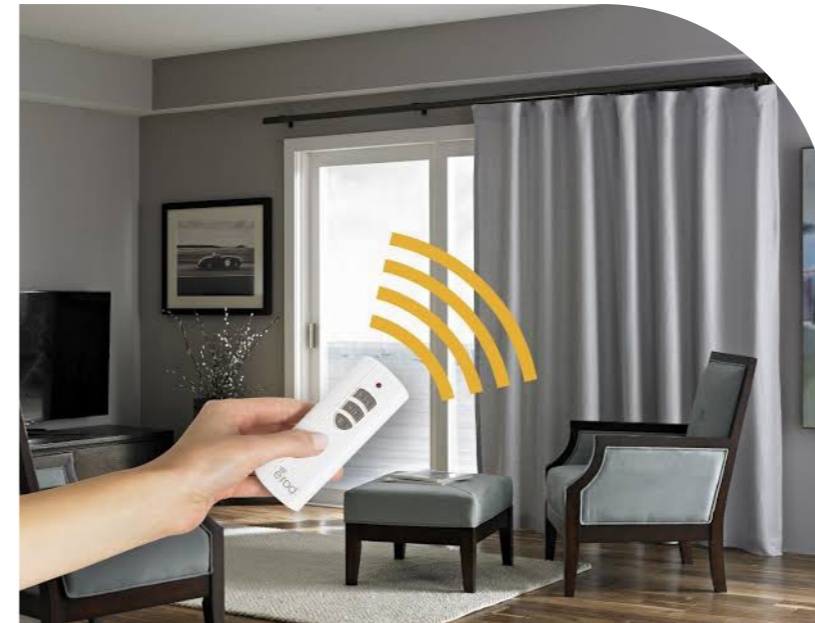



Commercial Service

Curtain Library & Blinds Express offers the following resources to Architects, Specifiers, Interior Designers and Project Managers.

TECHNICAL FABRIC SPECIFICATIONS

Detailed Specifications to assist in correctly specifying a product. These specifications include:

- Measured Solar Optical Properties Indoor
- Air Quality Certifications
- Anti Bacterial Certifications

- Flame Retardant Classifications
- Acoustical Data

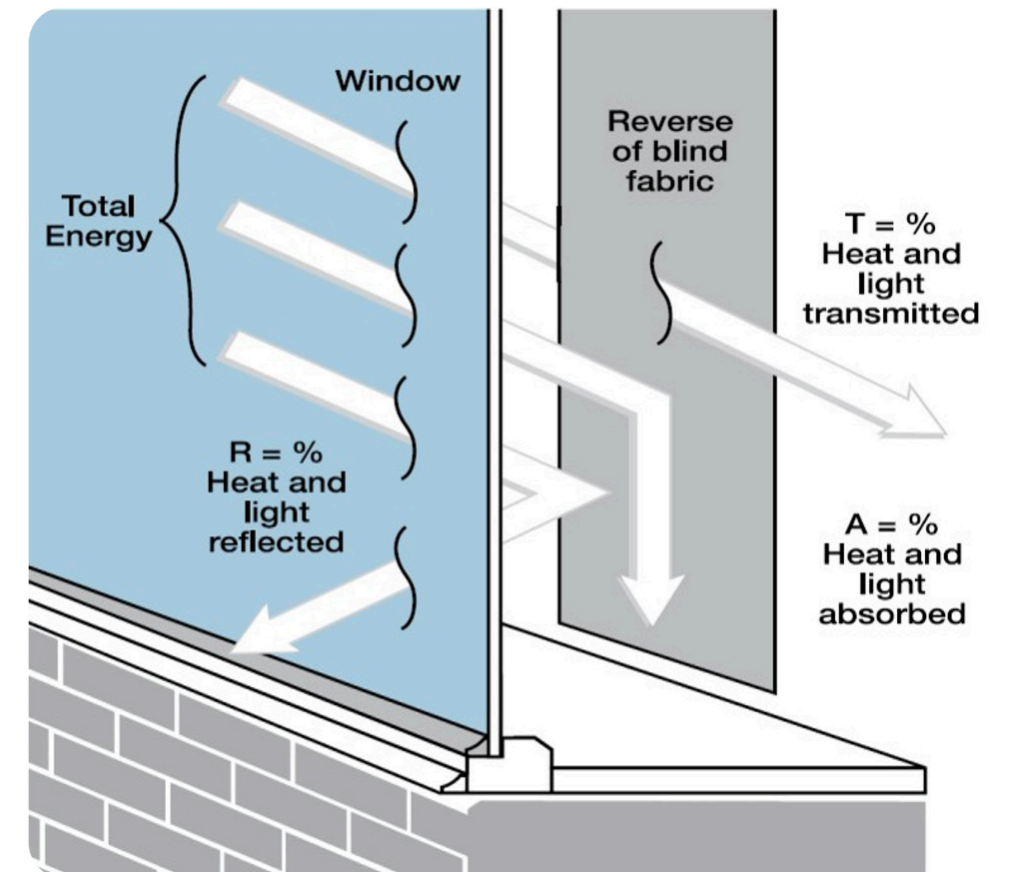

SOLAR GAIN

The amount of heat increase resulting from solar energy entering a room. It is the total of three separate parts - the amount of energy transmitted directly into the room, the energy which is absorbed by the blind and the proportion of energy which is absorbed by the window.

SHADING CO-EFFICIENT

The solar heat gain with the blind at the window divided by the solar heat gain with no blind at the window. The lower the shading co-efficient, therefore, the higher the efficiency of the fabric.

GTOT

When the G-value (a measure of total solar energy that passes through the glazing system and the blind fabric) of the glazing is combined with the value of the shading.

Commercial Service

SYSTEMS AND HARDWARE SPECIFICATIONS

Specifications to assist in correctly specifying your blind hardware system. These specifications include:

- Maximum Widths
- Maximum Drops
- System Drawings

- Weight Capacity Installation
- Fixing Options Material
- Composition

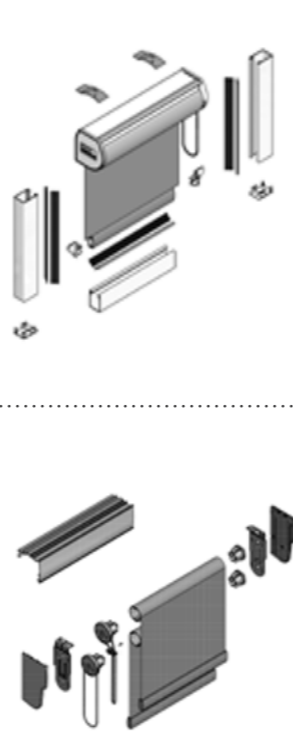
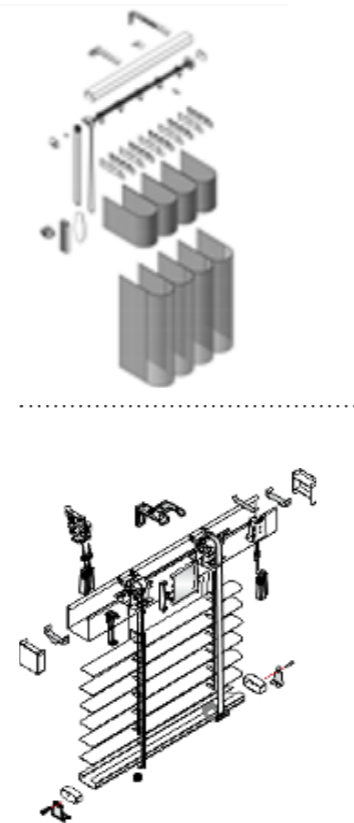

FABRIC SWATCHING SERVICE

Fabric swatch cuttings (a maximum of 10 fabrics per request) can be requested to assist in compiling storyboards and making colour selections. Please provide details of the range and colour requirements together with a delivery address and the fabric swatches will be delivered to you.





COMMERCIAL & RESIDENTIAL PROJECTS

www.blinds-express.co.za
info@blinds-express.co.za
Tel: 0117914351 / 0117911667
jacqueline@blinds-express.co.za
Cell: 0726070190

9 Homeworld Décor Centre
cnr. Malibongwe dr. & Rocky street
Ferndale
Randburg
2194

